

TS series

Proportional miniature thumb controls •
non-contacting Hall effect technology



DISTINCTIVE FEATURES

- One or two axis
- Analog, PWM or USB outputs
- IP67 Above panel sealing mounting
- Rear or drop-in mounting
- Pushbutton option



ENVIRONMENTAL SPECIFICATIONS

- Operating Temperature: -40 °C to +85 °C (-40 °F to +185 °F)
- Storage Temperature: -40 °C to +85 °C (-40 °F to +185 °F)
- Above Panel Sealing: IP67, IP69K¹ (subject to mounting style & final specifications)
- EMC Immunity Level: EN61000-4-3
- EMC Emissions Level: EN61000-6-3:2001
- ESD: EN61000-4-3 Level 2 (± 4 kv contact, ± 6 kv air)



SENSOR SPECIFICATIONS

- Technology: Hall effect sensors, single or dual
- Supply Voltage Range: 5.00 V ± 0.01 VDC
- Supply Current: 11 mA max
- Ratiometric Output Options: See options
- Reverse Polarity max: -10 V
- Transient overvoltage max: 16 V
- Start-up time: 15 ms max
- Output Impedance: 2Ω
- Return to Center Voltage Tolerance: ± 200 mV initial



U.S. Patent #D816,169 S
U.S. Patent #D732,047 S
U.S. Patent #D816,169 S
U.S. Patent #D734,138 S

The company reserves the right to change specifications without notice.

TS series

Proportional miniature thumb controls • non-contacting Hall effect technology



MECHANICAL SPECIFICATIONS

- Operating Force: 3.1 N ± 0.5 N (0.70 lbf ± 0.11 lbf)²
- Maximum Vertical Load: 200 N (45 lbf)²
- Maximum Horizontal Load: 150 N (33.7 lbf)²
- Mechanical Angle of Movement: 50° X & Y axis (subject to limiter plate)
- Expected Life: 1 million cycles
- Mass/Weight:
 - 18.25 g ± 5.0 g (plastic housing)
 - 39 g ± 6 g (metal housing)
- Lever Action (centering): Spring

¹ All options are IP67. IP69k can be achieved with the actuator 6,7 & 8, while selecting rear mount or threaded housing.

² Force applied to the top of the castle cap.



MATERIALS

- Body: Glass filled nylon
- Metal threaded Housing: Black oxide plated brass
- Boot: Silicone
- Handles:
 - 1, 2, 3, E, F, G - Glass filled nylon
 - 4, 5, 6, 7, 8 - Silicone
 - B, C, D - Thermoplastic elastomer
 - H - Polycarbonate

APEM products may be recycled at end-of-life for the re-claiming of valuable metal components.



CONNECTIONS

WIRING SPECIFICATION
(Termination options 1 & 2)

Black	Ground & button common, or LED common
Red	Power (5 V) ¹¹
Blue	X axis output (alpha)
Yellow	Y axis output (alpha)
Orange	Pushbutton switch (option 6 handle) or LED supply (option H handle) ²²
Blue/White Stripe	X axis output (beta)
Yellow/Black Stripe	Y axis output (beta)
Red/White Stripe	Power (5 V) (beta)
Black/White Stripe	Ground (beta)

¹¹ Hall sensor and LED supply (LED control option 1)

²² User controllable (LED control option 2)



PUSHBUTTON SWITCH SPECIFICATIONS (OPTION 6 HANDLE)

- Electrical Life: 100,000 cycles
- Rating: 50 mA, 12 VDC.
- Terminal: Brass with silver plating
- Contact Resistance: 100 mΩ max
- Insulation Resistance: 100 MΩ min. 500 VDC
- Dielectric Strength: 250 VAC /1 minute
- Contact Arrangement: 1 pole 1 throw
- Stop Strength: Max 3 kgf vertical static load for 15 seconds
- Operating Temperature: -25 °C to +70 °C (-4 °F to +158 °F)
- Storage Temperature: -30 °C to +85 °C (-22 °F to +158 °F)
- Vibration Resistance: MIL-STD-202F METHOD 201A
- Shock Resistance: MIL-STD-202F METHOD 213B



LED SPECIFICATIONS (OPTION H HANDLE)

LED CONTROL	OPERATING VOLTAGE	OPERATING CURRENT
1 – ON, driven by joystick supply voltage	-	25-30 mA
2 – User controlled	5 V	25-30 mA

TS series

Proportional miniature thumb controls • non-contacting Hall effect technology



NEW OPTIONS AVAILABLE

PLASTIC THREADED HOUSING



LED ILLUMINATION OPTION H HANDLE



MOUNTING

PLASTIC HOUSING - DROP-IN CUTOUT

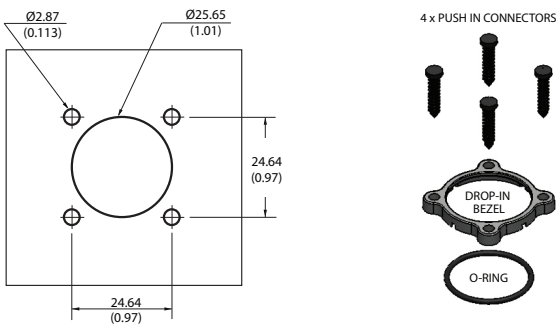

- The under panel depth for the Drop-in configuration is 16.02 mm (0.631 in).

PLASTIC HOUSING - REAR MOUNT OPTION CUTOUT

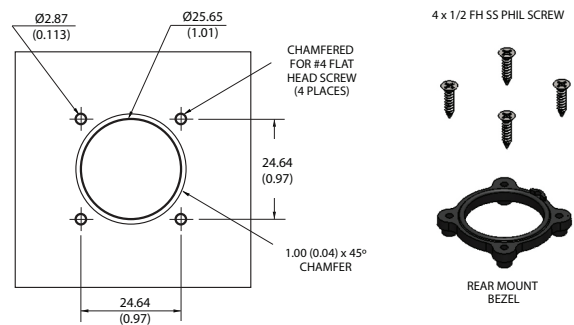

- The maximum panel thickness for the Rear Mount configuration is 2.032 mm (0.08 in).

- Mounting screws can be driven to a recommended torque of 4 lbf.

METAL THREADED HOUSING - DROP-IN CUTOUT

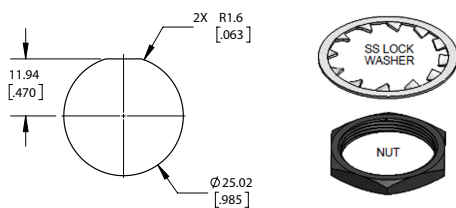

- The under panel depth for the Metal Threaded Housing configuration is 14.55 mm (0.573 in).
- Mounting nut can be tightened to a recommended torque of 10 in-lb.

PLASTIC THREADED HOUSING - DROP-IN CUTOUT

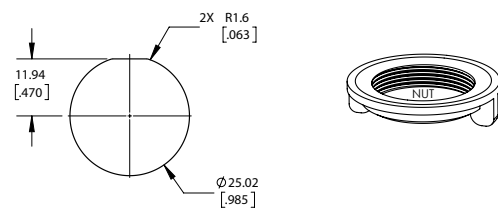

- The under panel depth for the Plastic Threaded Housing configuration is 14.55 mm (0.573 in).
- Mounting nut can be tightened to a recommended torque of 10 in-lb.

TS series

Proportional miniature thumb controls • non-contacting Hall effect technology



BUILD YOUR PART NUMBER

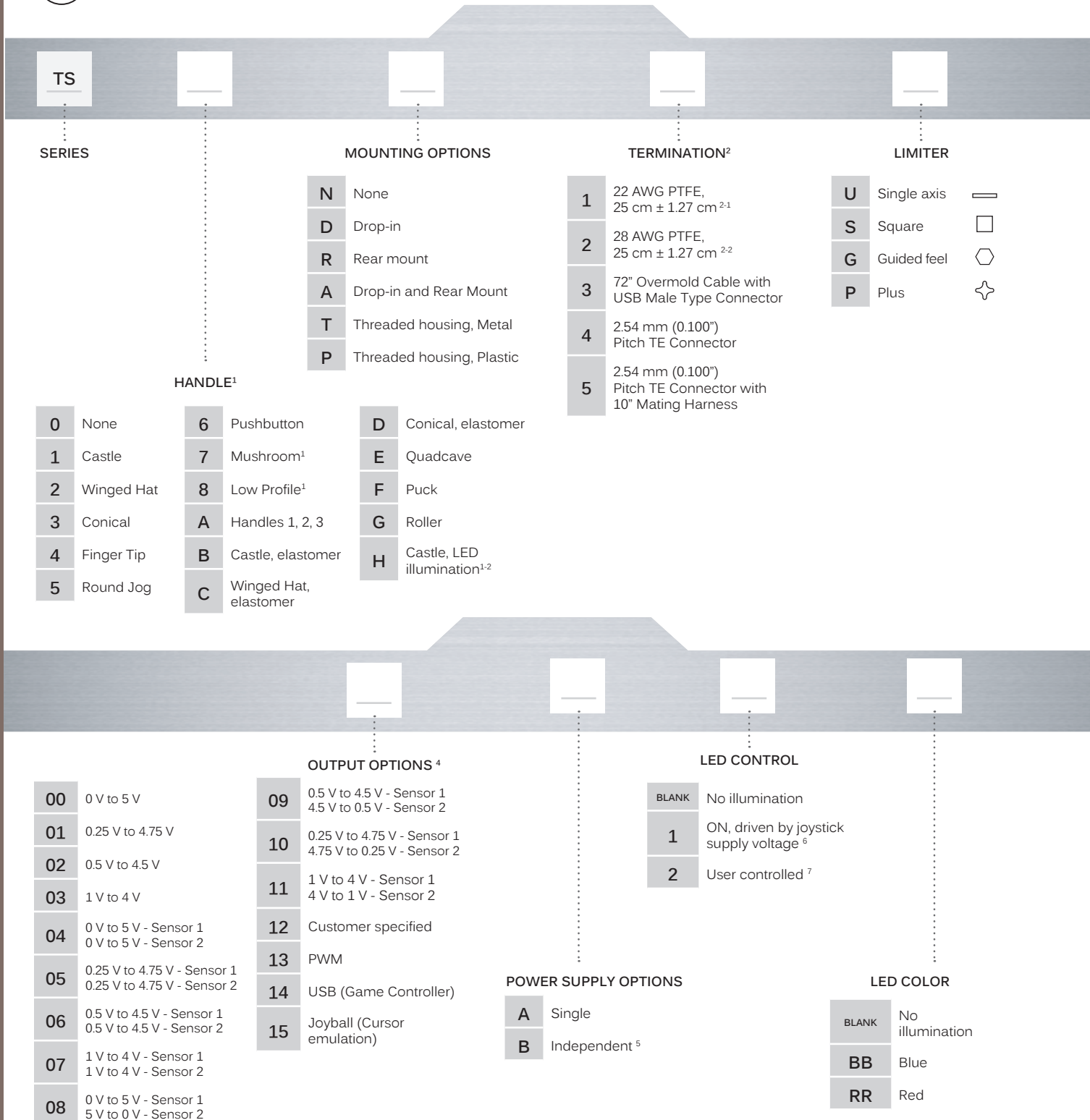

¹ Mushroom and Low Profile handles not available with P (threaded housing, plastic) or T (threaded housing, metal) housing options.

^{1,2} Contact factory if USB output is needed with illuminated castle actuator.

^{2,1} Wires are thick, robust, and best suited for stand alone applications.

^{2,2} Wires are thin and best suited for tightly constrained wire routing.

³ Contact factory for PWM configuration.

⁴ Output voltage is ratiometric to supply voltage.

⁵ Only available on dual output. Not available with Handle 6 (Pushbutton). Not available with termination options 4 or 5.

⁶ LED control is driven by joystick supply voltage. Illumination is constantly on

⁷ LED requires independent 5V supply. Illumination is user controlled.

TS series

Proportional miniature thumb controls • non-contacting Hall effect technology

PLASTIC HOUSING



METAL THREADED HOUSING



PLASTIC THREADED HOUSING

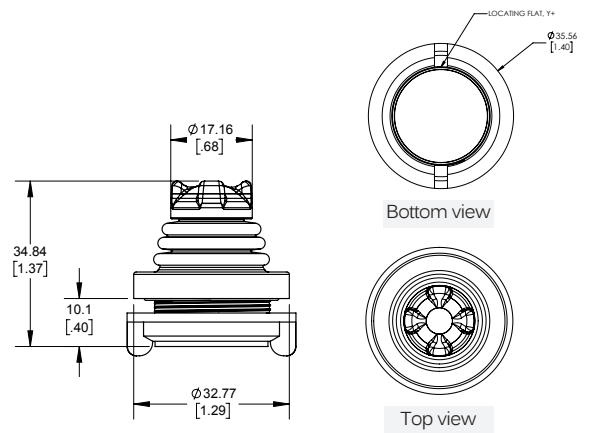
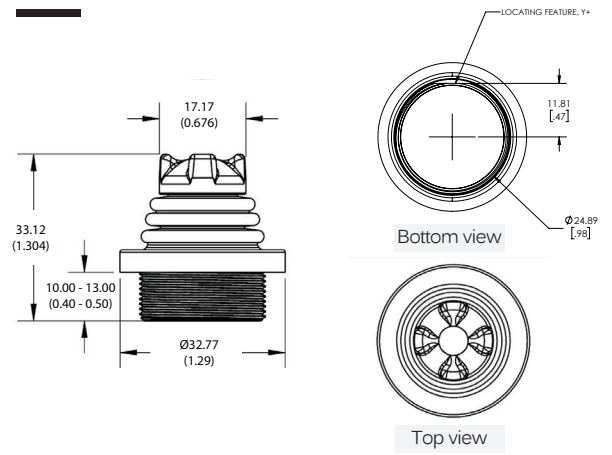
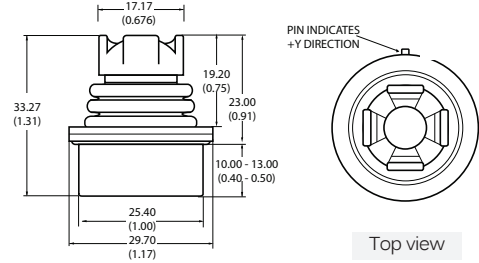

TS series

Proportional miniature thumb controls •
non-contacting Hall effect technology



HANDLE OPTIONS

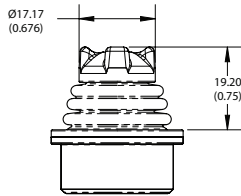

1 Castle
B Castle (elastomer)

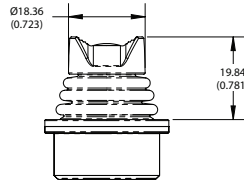

2 Winged hat
C Winged hat (elastomer)

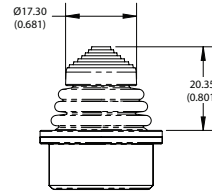

3 Conical
D Conical (elastomer)

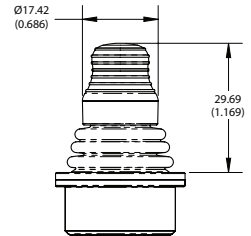

4 Fingertip

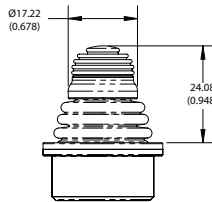

5 Round jog

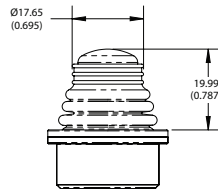

6 Pushbutton

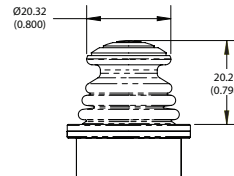

7 Mushroom

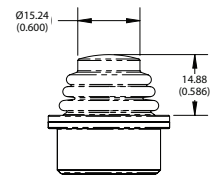

8 Low profile

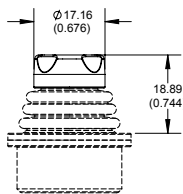

E Quadcave

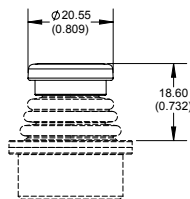

F Puck

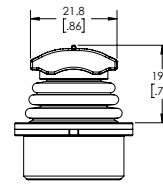

G Roller

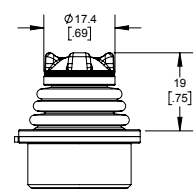

H Castle, LED illumination



USB OPTIONS

USB : GAME CONTROLLER

Featuring USB 2.0 HID compliant interface. APEM's USB joysticks are recognized as standard HID "game controller" devices. Adhering to the HID specification, APEM's USB joysticks are plug-and-play with most versions of Windows. Joystick button and axis assignments are dependent upon the controlled application.

- Features:
 - USB 2.0 HID compliant "game controller" device
 - Easy to install and operate
 - Functions determined by controlled application
- Supplied wiring: USB Male Type A Connector with 72" overmolded cable

USB: JOYBALL (CURSOR EMULATION)

The cursor emulation option converts a multi-axis joystick into a mouse or cursor control device

- Applications: The cursor emulation option is ideal for vehicle applications subjected to dirt and high vibration which makes operating a traditional cursor control device difficult. The Cursor Emulation option is widely used in shipboard and military applications.
- Features:
 - HID compliant "pointing device"
 - Plug-and-play with USB option
- Supplied wiring: USB Male Type A Connector with overmolded cable

Proportional miniature thumb controls • non-contacting Hall effect technology



VOLTAGE OUTPUT OPTIONS ¹

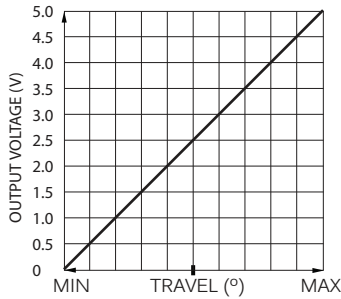

Option 00

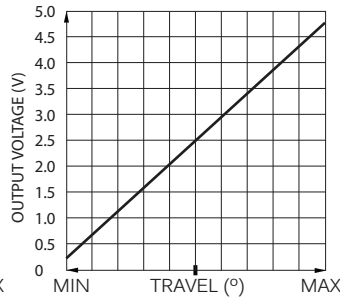

Option 01

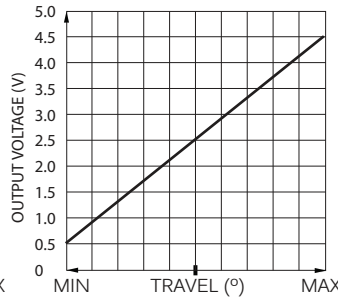

Option 02

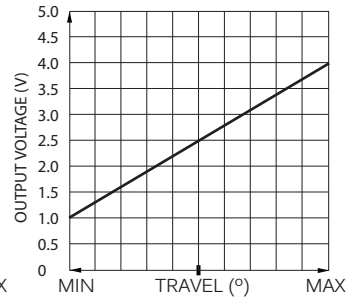

Option 03

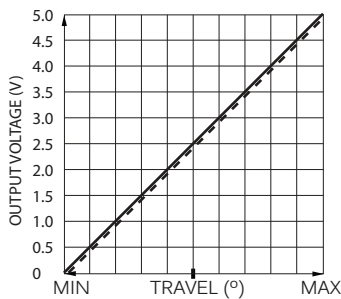

Option 04

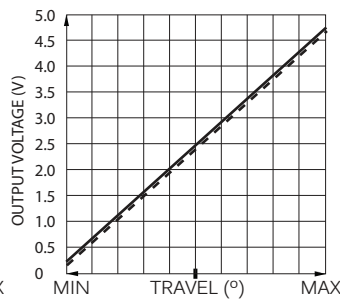

Option 05

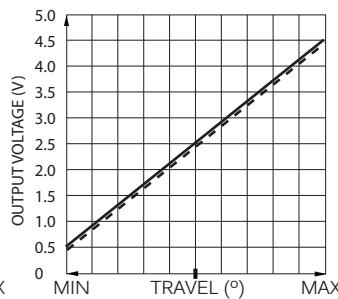

Option 06

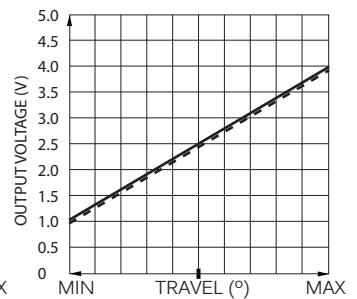

Option 07

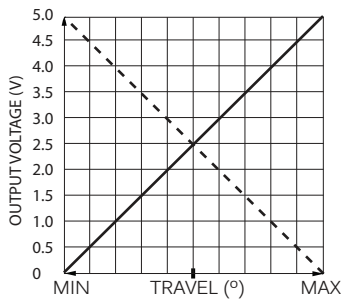

Option 08

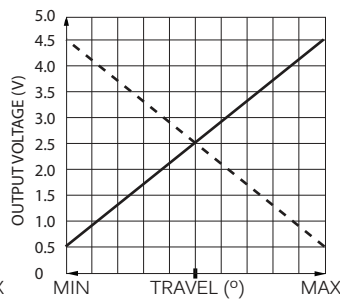

Option 09

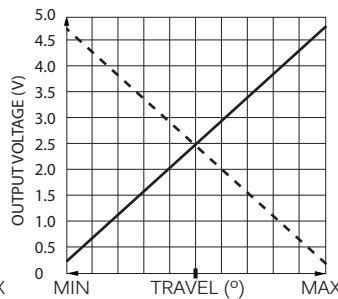

Option 10

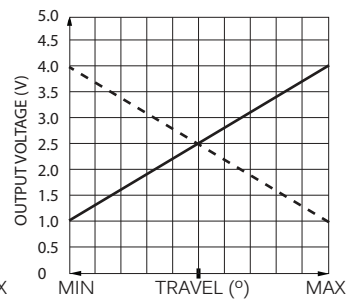

Option 11

————— Sensor 1
 - - - - - Sensor 2



CONNECTOR TERMINATION OPTION

PINOUT SPECIFICATION		
	TE 3-647166-5	TE 3-647166-7
PIN 1	Y (alpha)	Pushbutton / LED
PIN 2	5 VDC ¹	GND / Pushbutton common / LED common
PIN 3	X (alpha)	X (alpha)
PIN 4	GND/ Pushbutton common / LED common	Y (beta)
PIN 5	Pushbutton / LED	Y (alpha)
PIN 6	-	5 VDC
PIN 7	-	X (beta)

- Single output configurations feature a five position TE 3-647166-5 connector.
- Dual output configurations feature a seven position TE 3-647166-7 connector.
- A mating harness is not included, but may be specified for single output configurations at the time of order for an additional charge.
- The five function harness is part number 505-499.
- The seven function harness is part number 505-500.

¹ Voltage outputs are ratiometric to supply voltage